

LAMELLE ORIZZONTALI

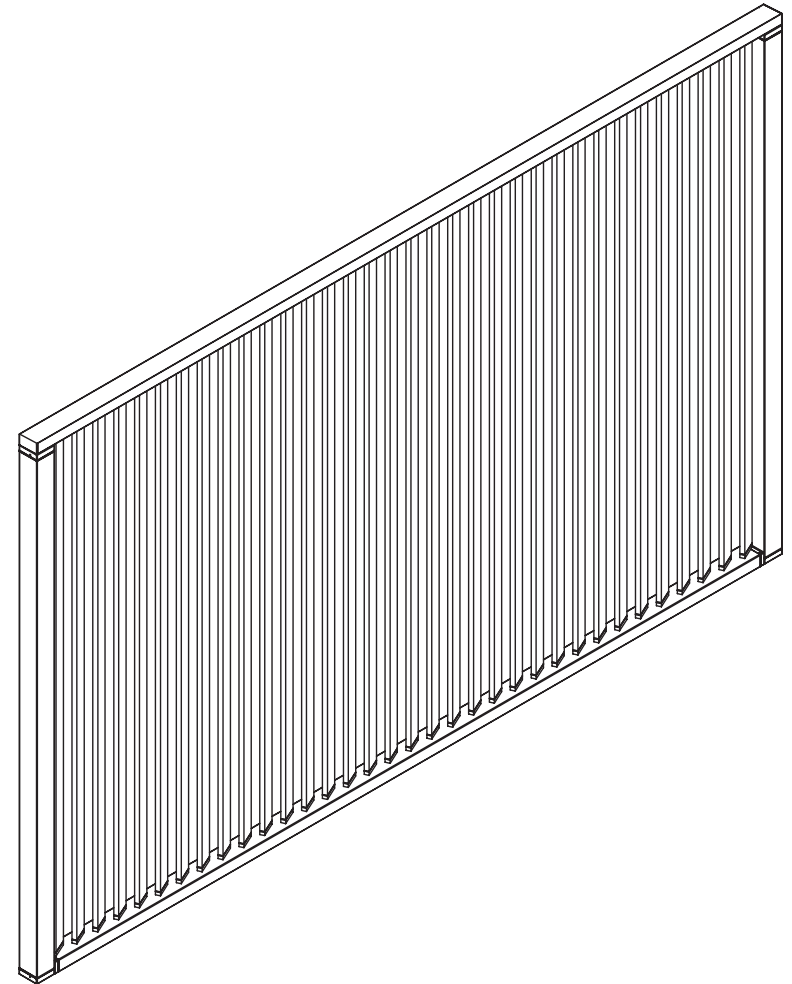

LAMELLE VERTICALI

FRANGISOLE FISSO

Profilo traversa
(optional)

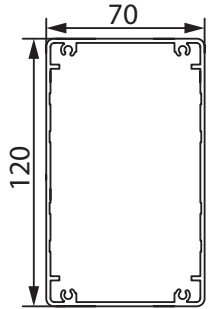

Innesto traversa
(optional)

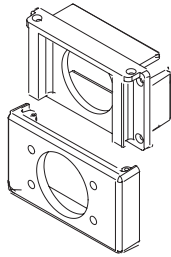

Tappo traversa
(optional)

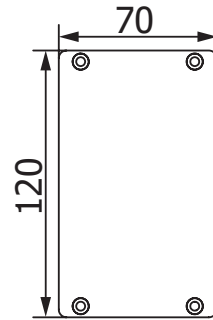

Gamba (Optional)

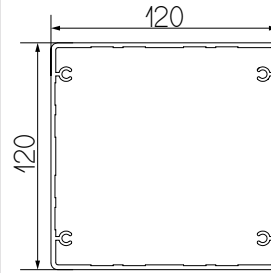

Piede (Optional)

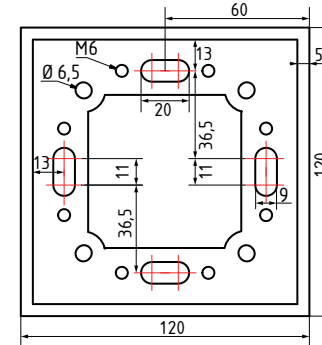

Tappo gamba
(Optional)

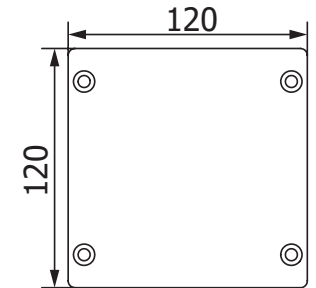

Portalamelle

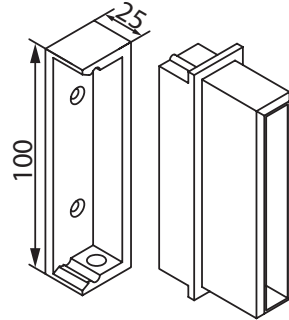

Lamella

